

## DATA SHEET EMG 105 SM

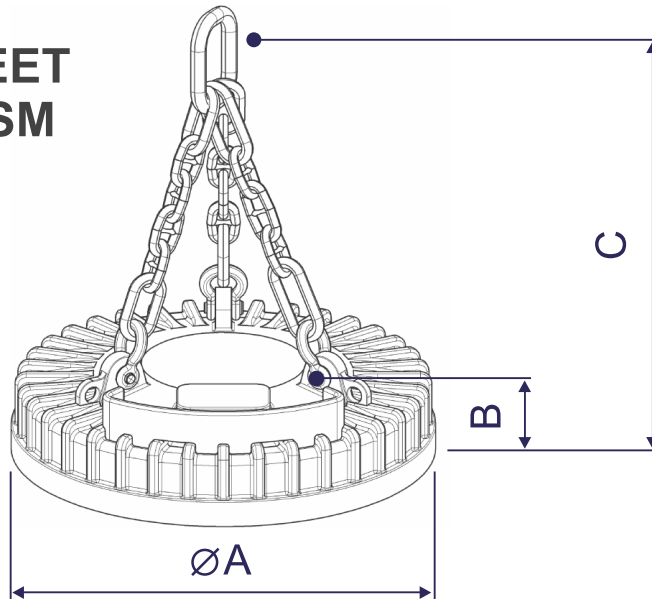

No	Property	Unit	Approved characteristic
1	Warranty term	month	24
2	Main technical properties		
2.1	Nominal voltage	V	220
2.2	Nominal current of the electromagnet at 20 °C	A	25 ± 8%
2.3	Nominal power	kW	5,5 ± 8%
2.4	Duty cycle	%	75
2.5	Pull-off force for a flat plate, at least	kg	17000
	Lifting capacity for cold cargo		
	plate, max		8500
	scrap with density of 2,4 t/m <sup>2</sup> , max		460
2.6	scrap with density of 1,6 t/m <sup>2</sup> , max	kg	290
	scrap with density of 0,8 t/m <sup>2</sup> , max		150
	steel turnings, max		220
	pig iron, max		540
2.7	Dimensions	mm	1050 x 300 x 1260
2.8	Winding material	-	Aluminium
2.9	Weight	kg	860 ± 5%
2.10	Protection class	-	IP 54
2.11	Ambient temperature	°C	-40...+45