

DATA SHEET EMG 125 SM

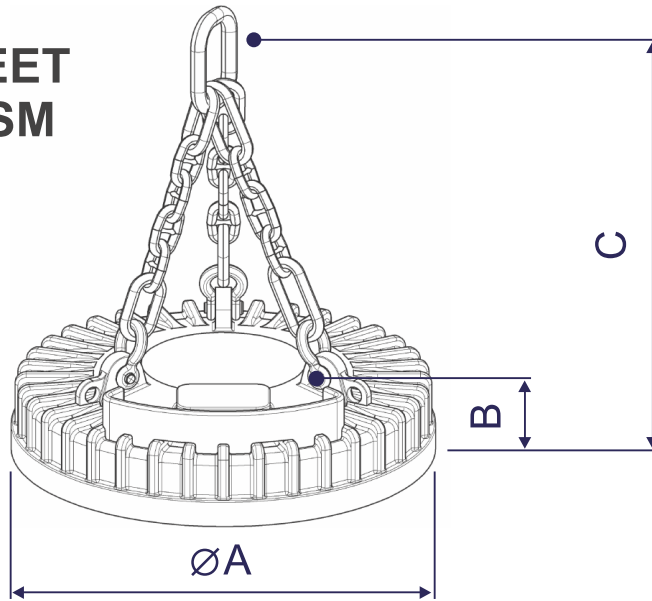

No	Property	Unit	Approved characteristic
1	Warranty term	month	24
2	Main technical properties		
2.1	Nominal voltage	V	220
2.2	Nominal current of the electromagnet at 20 °C	A	39 ± 8%
2.3	Nominal power	kW	8,6 ± 8%
2.4	Duty cycle	%	75
2.5	Pull-off force for a flat plate, at least	kg	26000
	Lifting capacity for cold cargo		
	plate, max		13000
	scrap with density of 2,4 t/m ² , max		850
2.6	scrap with density of 1,6 t/m ² , max	kg	540
	scrap with density of 0,8 t/m ² , max		330
	steel turnings, max		350
	pig iron, max		870
2.7	Dimensions	mm	1250 x 340 x 1300
2.8	Winding material	-	Aluminium
2.9	Weight	kg	1400 ± 5%
2.10	Protection class	-	IP 54
2.11	Ambient temperature	°C	-40...+45