

DATA SHEET EMG 135 SM

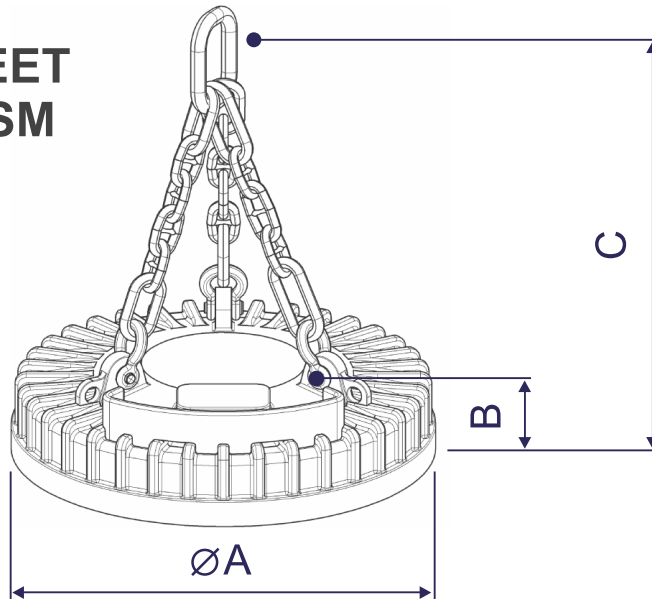

No	Property	Unit	Approved characteristic
1	Warranty term	month	24
2	Main technical properties		
2.1	Nominal voltage	V	220
2.2	Nominal current of the electromagnet at 20 °C	A	46 ± 8%
2.3	Nominal power	kW	10,1 ± 8%
2.4	Duty cycle	%	75
2.5	Pull-off force for a flat plate, at least	kg	30000
	Lifting capacity for cold cargo		
	plate, max		15000
	scrap with density of 2,4 t/m ² , max		1030
2.6	scrap with density of 1,6 t/m ² , max	kg	620
	scrap with density of 0,8 t/m ² , max		400
	steel turnings, max		410
	pig iron, max		1020
2.7	Dimensions	mm	1350 x 360 x 1440
2.8	Winding material	-	Aluminium
2.9	Weight	kg	1750 ± 5%
2.10	Protection class	-	IP 54
2.11	Ambient temperature	°C	-40...+45