

DATA SHEET EMG 155 SM

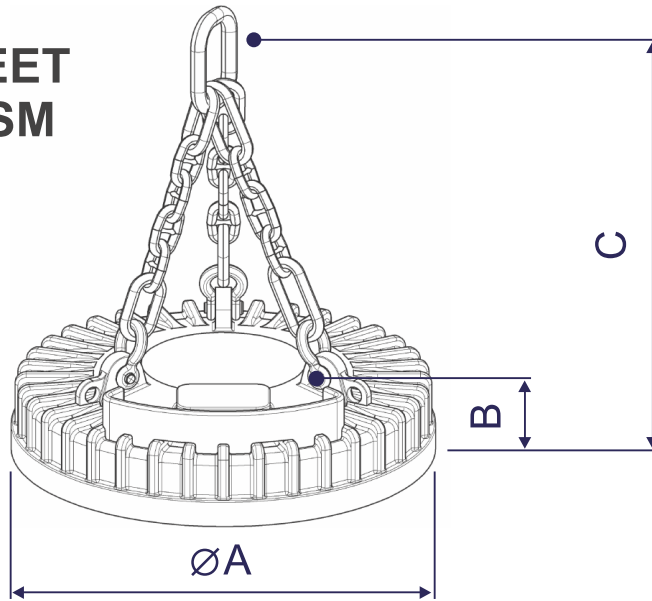

No	Property	Unit	Approved characteristic
1	Warranty term	month	24
2	Main technical properties		
2.1	Nominal voltage	V	220
2.2	Nominal current of the electromagnet at 20 °C	A	61 ± 8%
2.3	Nominal power	kW	13,4 ± 8%
2.4	Duty cycle	%	75
2.5	Pull-off force for a flat plate, at least	kg	40000
	Lifting capacity for cold cargo		
	plate, max		20000
	scrap with density of 2,4 t/m ² , max		1510
2.6	scrap with density of 1,6 t/m ² , max	kg	1000
	scrap with density of 0,8 t/m ² , max		620
	steel turnings, max		600
	pig iron, max		1480
2.7	Dimensions	mm	1550 x 420 x 1620
2.8	Winding material	-	Aluminium
2.9	Weight	kg	2700 ± 5%
2.10	Protection class	-	IP 54
2.11	Ambient temperature	°C	-40...+45